

Nominal data

Type	7855 ES	
Phase		1~
Nominal voltage	VAC	230
Frequency	Hz	50
Speed	min ⁻¹	2800
Power input	W	45.0
Min. ambient temperature	°C	-25
Max. ambient temperature	°C	50
Air flow	m ³ /h	325
Sound power level	B	6.0
Sound pressure level	dB(A)	49

ml = Max. load · me = Max. efficiency · fa = Running at free air · cs = Customer specs · cu = Customer unit
Subject to alterations

7855 ES

AC axial compact fan

Technical features

Mass	1.1 kg
Dimensions	150 Ø x 55 mm
Material of impeller	Sheet steel, coated in black
Housing material	Die-cast aluminium
Direction of air flow	Exhaust over struts
Direction of rotation	Left, looking at rotor
Bearing	Ball bearings
Lifetime L10 at 40 °C	60000 h
Lifetime L10 at maximum temperature	47500 h
Connection line	With 2 single strands. Strand ends with lead tips. Grounding lug for M4 x 8.
Motor protection	Protected from overload by a thermal switch
Approval	VDE, CSA, UL, CE

7855 ES

AC axial compact fan

Product drawing

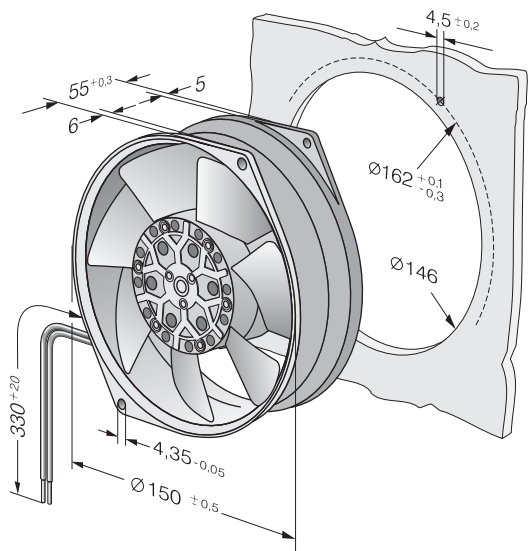

Charts: Air flow

